

STANDARD HINGE & STRIKE LOCATION PREFITTING INSTRUCTIONS

STANDARD HARDWARE PREPS

RFS #	HEIGHT	HINGE	STRIKE PREP	DOOR THICKNESS
1	6'8" 6'9" 7'0"	235	2 3/4" "T"	1 3/8" Single Door
2	6'8" 6'9" 7'0"	235	none	1 3/8" Single Door
3	6'8" 6'9" 7'0"	335	2 3/4" "T"	1 3/8" Single Door
4	6'8" 6'9" 7'0"	335	none	1 3/8" Single Door
5	6'8" 6'9" 7'0"	340	ASA or 2 3/4" "T"	1 3/4" Single Door
6	6'8" 6'9" 7'0"	340	none	1 3/4" Single Door
7	6'8" 6'9" 7'0"	235	n/a	1 3/8" Pair Door
8	6'8" 6'9" 7'0"	335	n/a	1 3/8" Pair Door
9	6'8" 6'9" 7'0"	340	n/a	1 3/4" Pair Door
10	6'8" 7'0" 8'0" 10'0"	none	none	Framed With Stops; No Preps
11	6'8" 7'0" 8'0"	n/a	n/a	Cased Opening; No Stop
12	6'8" 7'0"	n/a	n/a	Pocket Door, Single Door, 1-3/8" or 1-3/4" Door
13	6'8" 7'0"	n/a	n/a	Pocket Door, Pair Doors, 1-3/8" or 1-3/4" Door
14	6'8" 7'0"	Profile Commun. 235	2 3/4" "T"	Commun. Door 1 3/8" x 1 3/4", RFS 1 x RFS 5
16	6'8" 7'0"	Profile Dutch 435	2 3/4" "T"	Dutch Door 1 3/8"
17	7'10" 8'0" 8'4" 8'10"	435	2 3/4" "T"	1 3/8" Single Door
19	7'10" 8'0" 8'4" 8'10"	440	ASA or 2 3/4" "T"	1 3/4" Single Door
21	7'10" 8'0" 8'4" 8'10"	435	n/a	1 3/8" Pair Door
22	7'10" 8'0" 8'4" 8'10"	440	n/a	1 3/4" Pair Door
31	6'8" 6'9" 7'0"	345	ASA or 2 3/4" "T"	1 3/4" Single Door
32	6'8" 6'9" 7'0"	345	none	1 3/4" Single Door
33	6'8" 6'9" 7'0"	345	n/a	1 3/4" Pair Door
34	6'8" 7'0"	Profile Commun. 235/345	2 3/4" "T"	Commun. Door 1 3/8" x 1 3/4", RFS 1 x RFS 31
35	7'10" 8'0" 8'4" 8'10"	445	ASA or 2 3/4" "T"	1 3/4" Single Door
36	7'10" 8'0" 8'4" 8'10"	445	none	1 3/4" Single Door
37	7'10" 8'0" 8'4" 8'10"	445	n/a	1 3/4" Pair Door
38	6'8" 7'0"	Profile Commun. 340/340	ASA or 2 3/4" "T"	Commun. Door 1 3/4" x 1 3/4", RFS 5 x RFS 5
39	6'8" 7'0"	Profile Commun. 345/345	ASA or 2 3/4" "T"	Commun. Door 1 3/4" x 1 3/4", RFS 31 x RFS 31
40	6'8" 7'0"	Profile Dutch 440	ASA or 2 3/4" "T"	Dutch Door 1 3/4"
41	6'8" 7'0"	Profile Dutch 440	ASA or 2 3/4" "T"	Dutch Door 1 3/4"
42	6'8" 7'0"	Profile Commun. 235/235	2-3/4" "T"	Commun. Door, 1-3/8" x 1-3/8" Door, RFS 1 x RFS 1
43	6'8" 7'0"	Profile Commun. 335/335	2-3/4" "T"	Commun. Door, 1-3/8" x 1-3/8" Door, RFS 3 x RFS 3
44	6'8" 7'0"	Profile Commun. 335/340	2-3/4" "T"	Commun. Door, 1-3/8" x 1-3/4" Door, RFS 3 x RFS 5
45	6'8" 7'0"	Profile Commun. 335/345	2-3/4" "T"	Commun. Door, 1-3/8" x 1-3/4" Door, RFS 3 x RFS 31
46	7'10" 8'0" 8'4" 8'10"	Profile Commun. 345/345	ASA or 2-3/4" "T"	Commun. Door, 1-3/4" x 1-3/4" Door, RFS 35 x RFS 35

*NOTE: 1-3/4" Single swing doors available with 2-3/4" adjustable T-Strike prep or 4-7/8" ASA strike. Please specify when ordering.

3	Table of Contents
4	Standard Frame Sizes / Hinge and Strike Specifications
5	1-3/8" Door with 1 pair 3-1/2" Hinges
6	1-3/8" Door with 1-1/2 pair 3-1/2" Hinges
7	1-3/8" Door with 2 pair 3-1/2" Hinges
8	1-3/4" Door with 1-1/2 pair 4" Hinges
9	1-3/4" Door with 2 pair 4" Hinges
10	1-3/4" Door with 1-1/2 pair 4-1/2" Hinges
11	1-3/4" Door with 2 pair 4-1/2" Hinges
12	Dutch Door Prep; 1-3/8" Door with 2 Pair of 3-1/2" Hinges
13	Dutch Door Prep; 1-3/4" Door with 2 Pair of 4" Hinges
14	Dutch Door Prep; 1-3/4" Door with 2 Pair of 4-1/2" Hinges
15	1-3/4" Door with 1-1/2 pair 5" Hinges

STANDARD FRAME SIZES							
WIDTHS (SINGLES)	1'6" 3'0"	1'8" 3'4"	2'0" 3'6"	2'4" 3'8"	2'6" 4'0"	2'8"	2'10"
WIDTHS (PAIRS)	4'0"	4'6"	5'0"	5'4"	5'6"	6'0"	
HEIGHTS	6'8" (80-3/16")	6'9" (81-3/16")	7'0" (84-3/16")	7'10" (94-3/16")	8'0" (96-3/16")	8'4" (100-3/16")	8'10" (106-3/16")

HINGE PREP SPECIFICATIONS									
FRAME TYPE				HINGE SIZE	TYPE	FRAME DEPTH	PATTERN	SCREW SIZE	DOOR THICKNESS
RF	KRF	RFX	KRFX						
Std	-	-	-	3-1/2"	1/4" RADIUS CORNER	.120	TEMPLATE	#10-24 MS	1-3/8"
Opt/NC	-	-	-	3-1/2"	5/8" RADIUS CORNER	.120	TEMPLATE	#10-24 MS	1-3/8"
Std	Std	Std	Std	4"	1/4" RADIUS CORNER	.125	TEMPLATE	#12-24 MS	1-3/4"
Opt/NC	Opt/NC	Opt/NC	Std	4"	5/8" RADIUS CORNER	.115	TEMPLATE OR NON-TEMPLATE	#10-24 MS	1-3/4"
Std	Std	Std	Std	4-1/2"	SQUARE CORNER	.134	TEMPLATE	#12-24 MS	1-3/4"
Opt/Upchg	Opt/Upchg	-	-	4-1/2" Heavyweight	SQUARE CORNER	.180	TEMPLATE	#12-24 MS	1-3/4"
Opt/Upchg	Opt/Upchg	-	-	5"	SQUARE CORNER	.145	TEMPLATE	#12-24 MS	1-3/4"

General Notes: RF = Standard Rediframe
KRF = Kerf Rediframe
RFX = Standard Rediflex
KRFX = Kerf Rediflex

Note: See machining instructions for recommended door hinge backsets.

STRIKE PREP SPECIFICATIONS									
FRAME TYPE				STRIKE SIZE	TYPE	FRAME DEPTH	SCREW SIZE	DOOR THICKNESS	
RF	KRF	RFX	KRFX						
Std	-	-	-	1-1/4" X 2-3/4"	ADJUSTABLE "T" STRIKE EMBOSS	.110	#8-32 ST	1-3/8"	
Std	Std	Std	Std	1-1/4" X 2-3/4"	ADJUSTABLE "T" STRIKE EMBOSS	.110	#8-32 ST	1-3/4"	
Std	Std	Std	Std	1-1/4" X 4-7/8"	ADJUSTABLE ASA STRIKE EMBOSS (1-3/4" DOORS ONLY) (PATENTED)	.125	#12-24 MS	1-3/4"	
Opt/Upchg	Opt/Upchg	Opt/Upchg	Opt/Upchg	1-1/8" X 2-3/4"	DEADBOLT STRIKE EMBOSS (1-3/4" DOORS ONLY)	.110	#8-32 ST	1-3/4"	
Opt/NC	Opt/NC	Opt/NC	Opt/NC	1-1/2" X 2-1/4"	FULL LIP STRIKE	.110	#8-32 ST	1-3/4"	

1-3/8" DOOR WITH 1-1/2 PAIR OF 3-1/2" HINGES

NET FRAME DIMENSIONS				
RFS 3, RFS 4, RFS 8				
NOM HGT.	NET HGT.	"A"	"B"	"C"
5'-0	60-3/16	10-3/32	20	20-3/32
5'-1	61-3/16	10-3/32	20-1/2	21-3/32
5'-2	62-3/16	10-3/32	21	22-3/32
5'-4	64-3/16	10-3/32	22	24-3/32
6'-0	72-3/16	10-3/32	26	32-3/32
6'-8	80-3/16	10-3/32	30	40-3/32
6'-9	81-3/16	10-3/32	30-1/2	41-3/32
7'-0	84-3/16	10-3/32	32	44-3/32
7'-4	88-3/16	10-3/32	34	48-3/32
7'-6	90-3/16	10-3/32	35	50-3/32

DOOR PREFITTING: Deduct 3/32" from dimensions "A" and "C" for clearances.

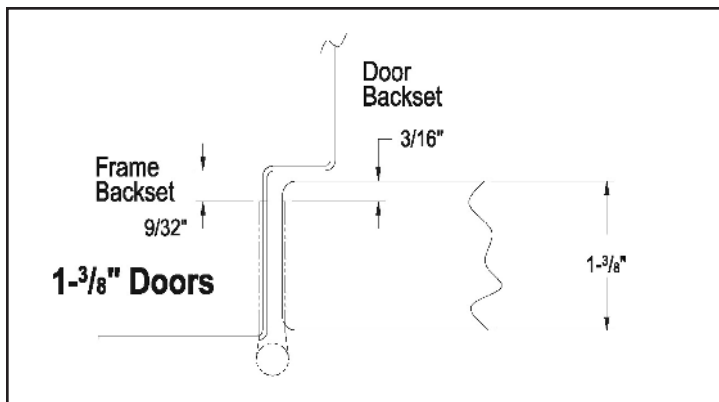
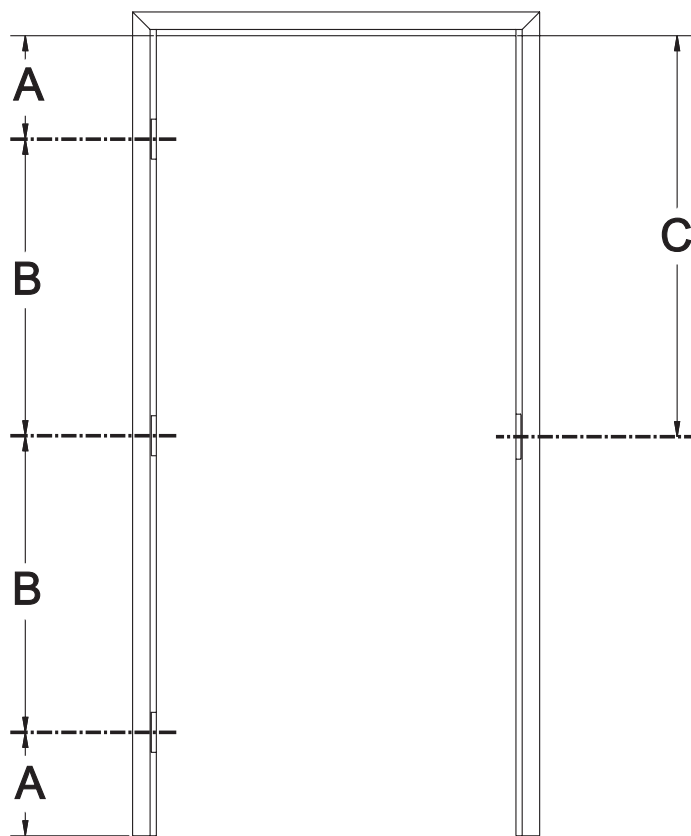

DOOR INFORMATION:

Hinge Backset = 3/16"
Hinge Depth = Per Template
Template hinge pattern only; 1/4" or 5/8" radius

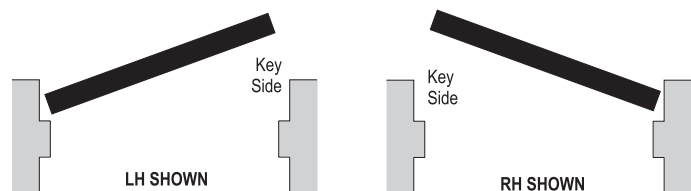
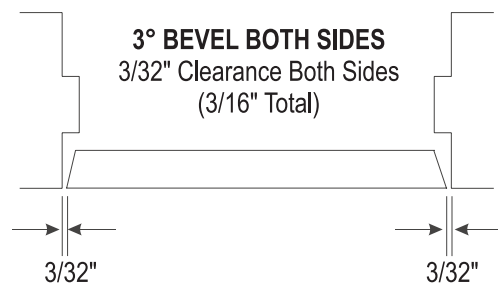

1-3/4" DOOR WITH 1-1/2" PAIR OF 4" HINGES

NET FRAME DIMENSIONS

RFS 5, RFS 6, RFS 9

NOM HGT.	NET HGT.	"A"	"B"	"C"
5'-0	60-3/16	10-11/32	19-3/4	20-3/32
5'-1	61-3/16	10-11/32	20-1/4	21-3/32
5'-2	62-3/16	10-11/32	20-3/4	22-3/32
5'-4	64-3/16	10-11/32	21-3/4	24-3/32
6'-0	72-3/16	10-11/32	25-3/4	32-3/32
6'-8	80-3/16	10-11/32	29-3/4	40-3/32
6'-9	81-3/16	10-11/32	30-1/4	41-3/32
7'-0	84-3/16	10-11/32	31-3/4	44-3/32
7'-4	88-3/16	10-11/32	33-3/4	48-3/32
7'-6	90-3/16	10-11/32	34-3/4	50-3/32

DOOR PREFITTING: Deduct 3/32" from dimensions "A" and "C" for clearances.

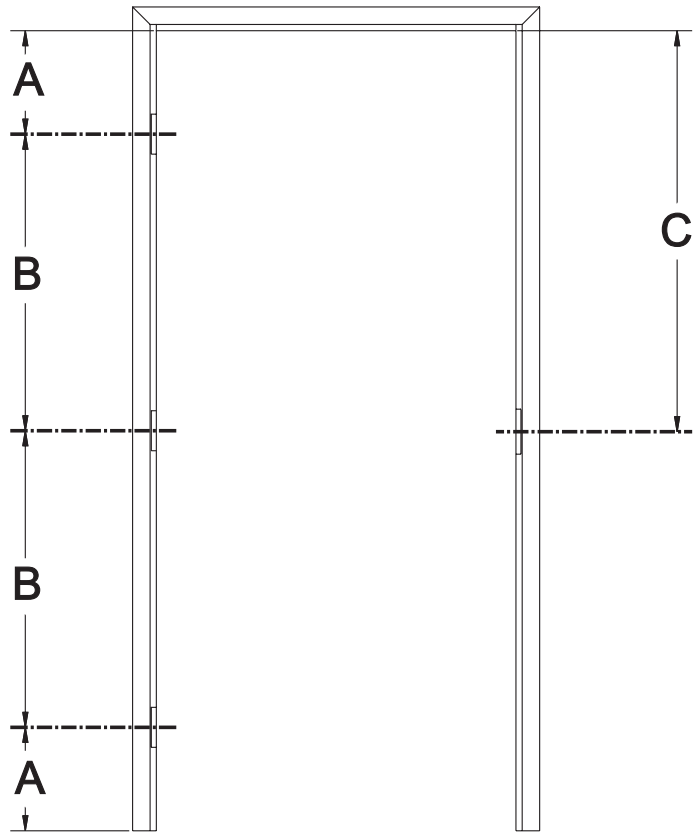

DOOR INFORMATION:

Hinge Backset = 1/4"
 Hinge Depth = Per Template
 Template hinge pattern only; 1/4" radius only
 5/8" radius hinge prep available in template or non-template hole pattern; specify hinge when ordering

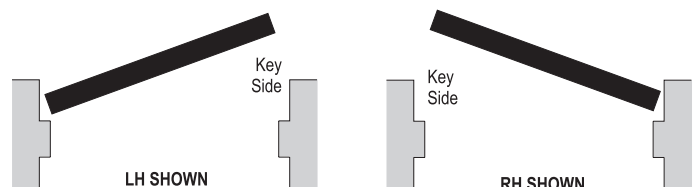
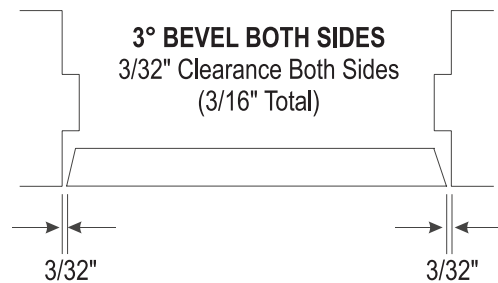
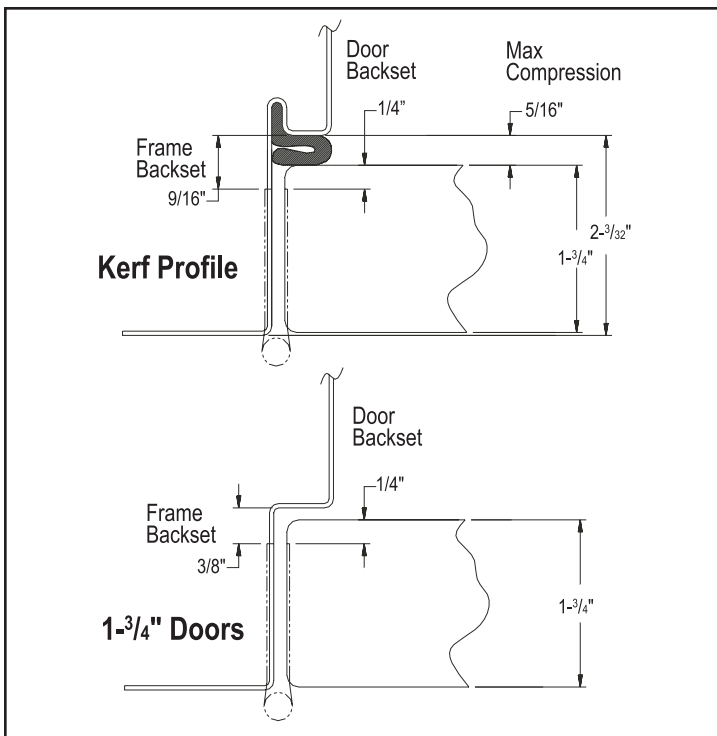

STANDARD HINGE AND STRIKE LOCATIONS

1-3/4" DOOR WITH 2 PAIR OF 4" HINGES

NET FRAME DIMENSIONS					
RFS 19, RFS 22					
NOM HGT.	NET HGT.	"A"	"B"	"C"	"D"
6'-0	72-3/16	10-11/32	17	17-1/2	32-3/32
6'-8	80-3/16	10-11/32	19-3/4	20	40-3/32
6'-9	81-3/16	10-11/32	20-1/8	20-1/4	41-3/32
6'-10	82-3/16	10-11/32	20-1/2	20-1/2	42-3/32
7'-0	84-3/16	10-11/32	21	21-1/2	44-3/32
7'-2	86-3/16	10-11/32	21-3/4	22	46-3/32
7'-4	88-3/16	10-11/32	22-1/2	22-1/2	48-3/32
7'-6	90-3/16	10-11/32	23	23-1/2	50-3/32
7'-8	92-3/16	10-11/32	23-3/4	24	52-3/32
7'-10	94-3/16	10-11/32	24-1/2	24-1/2	54-3/32
8'-0	96-3/16	10-11/32	25	25-1/2	56-3/32
8'-2	98-3/16	10-11/32	25-3/4	26	58-3/32
8'-4	100-3/16	10-11/32	26-1/2	26-1/2	60-3/32
8'-6	102-3/16	10-11/32	27	27-1/2	62-3/32
8'-8	104-3/16	10-11/32	27-3/4	28	64-3/32
8'-10	106-3/16	10-11/32	28-1/2	28-1/2	66-3/32
9'-0	108-3/16	10-11/32	29	29-1/2	68-3/32

DOOR PREFITTING: Deduct 3/32" from dimensions "A" and "D" for clearances.

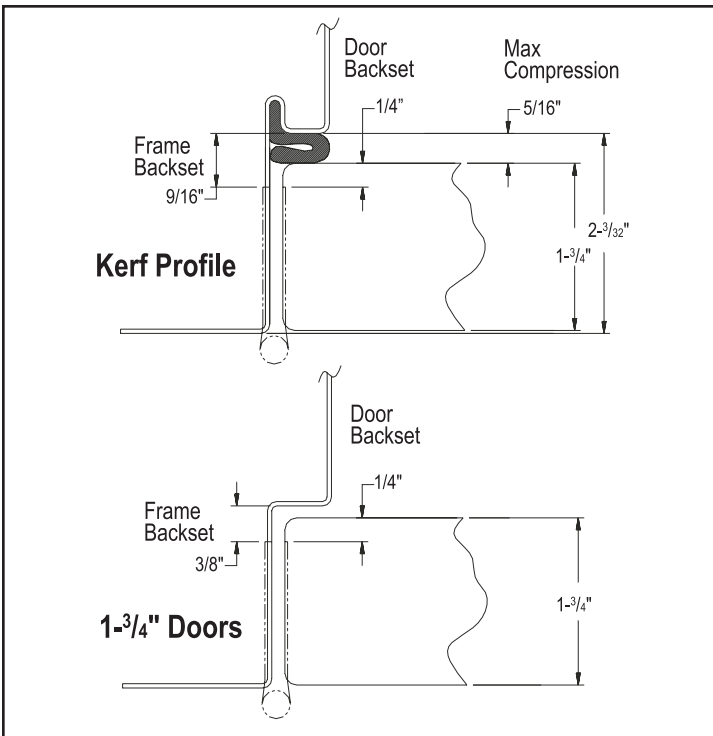
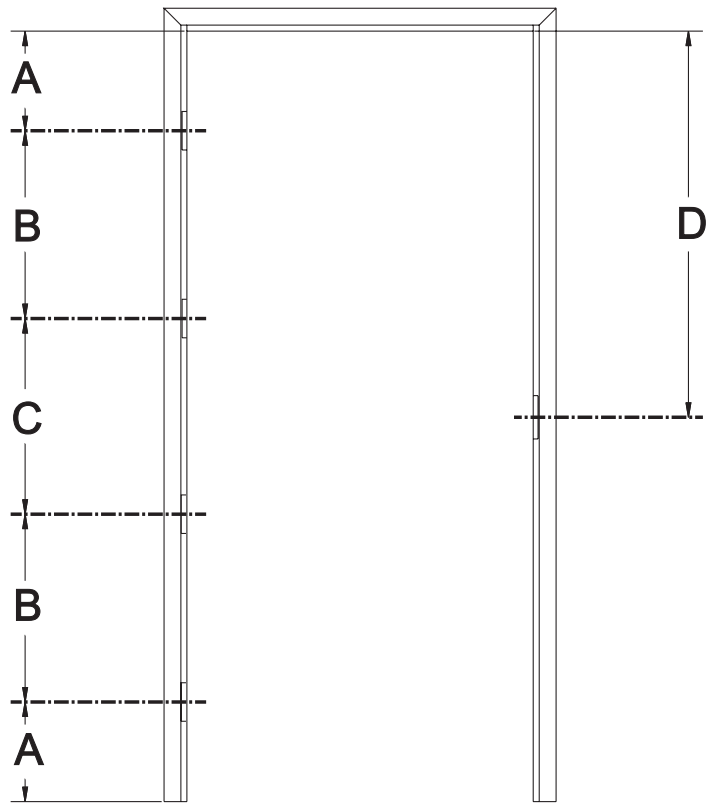

DOOR INFORMATION:
 Hinge Backset = 1/4"
 Hinge Depth = Per Template
 Template hinge pattern only; 1/4" radius only
 5/8" radius hinge prep available in template or non-template hole pattern; specify hinge when ordering

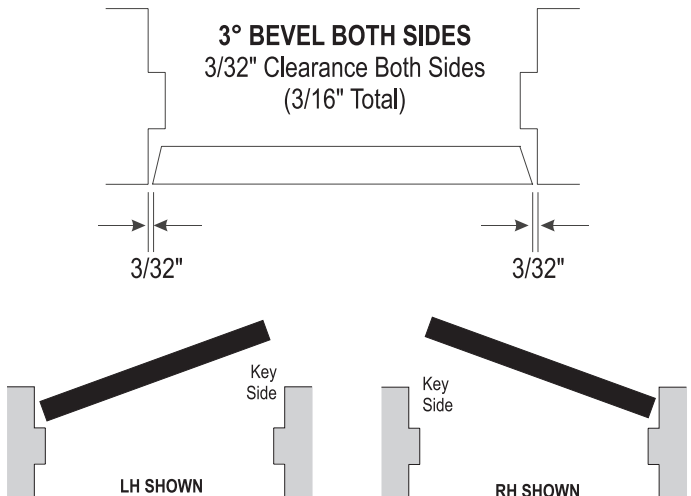

1-3/4" DOOR WITH 1-1/2 PAIR OF 4-1/2" HINGES

NET FRAME DIMENSIONS				
RFS 31, RFS 32, RFS 33				
NOM HGT.	NET HGT.	"A"	"B"	"C"
5'-0	60-3/16	10-19/32	19-1/2	20-3/32
5'-1	61-3/16	10-19/32	20	21-3/32
5'-2	62-3/16	10-19/32	20-1/2	22-3/32
5'-4	64-3/16	10-19/32	21-1/2	24-3/32
6'-0	72-3/16	10-19/32	25-1/2	32-3/32
6'-8	80-3/16	10-19/32	29-1/2	40-3/32
6'-9	81-3/16	10-19/32	30	41-3/32
7'-0	84-3/16	10-19/32	31-1/2	44-3/32
7'-4	88-3/16	10-19/32	33-1/2	48-3/32
7'-6	90-3/16	10-19/32	34-1/2	50-3/32

DOOR PREFITTING: Deduct 3/32" from dimensions "A" and "C" for clearances.

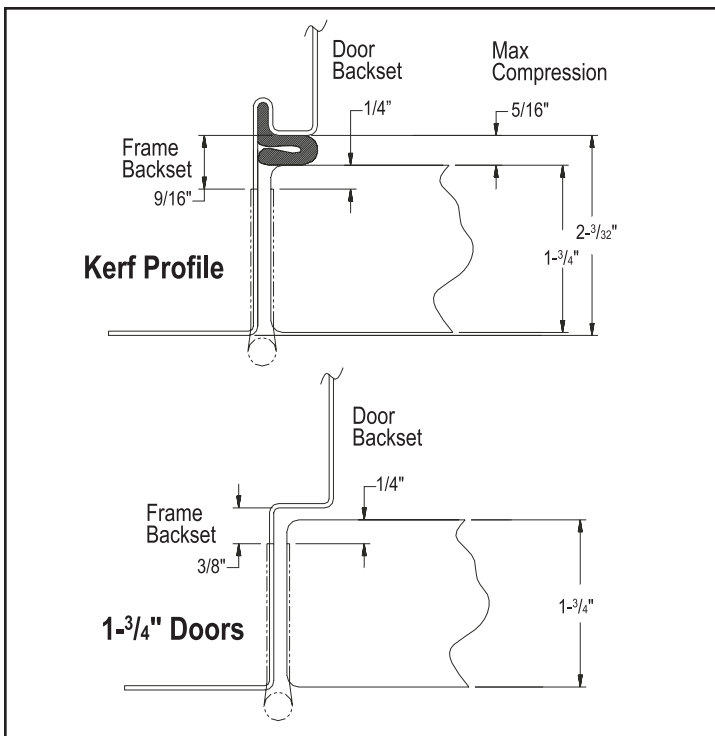
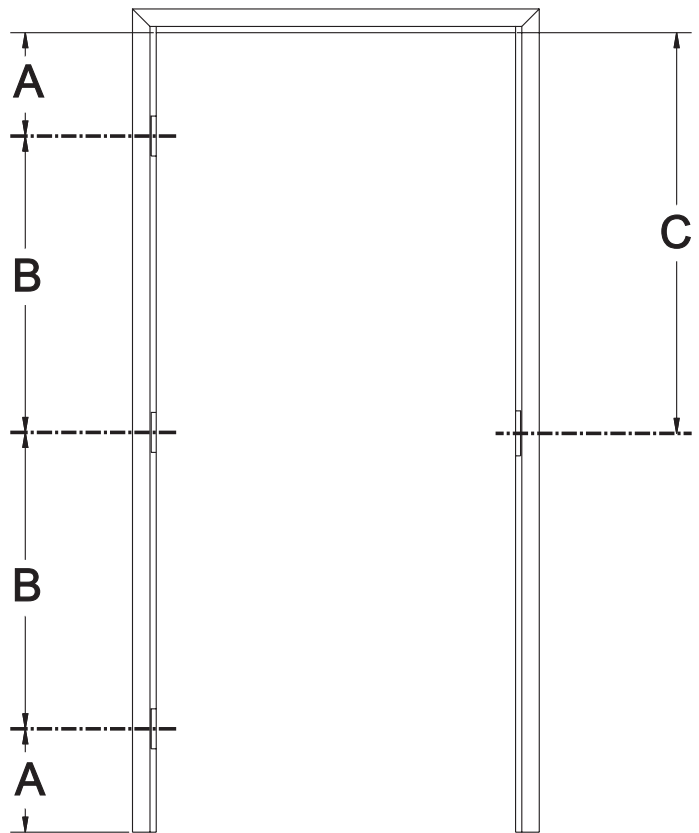

DOOR INFORMATION:

Hinge Backset = 1/4"
 Hinge Depth = .134" for standard weight hinge
 Hinge Depth = .180" for heavy weight hinge
 Template hinge pattern only

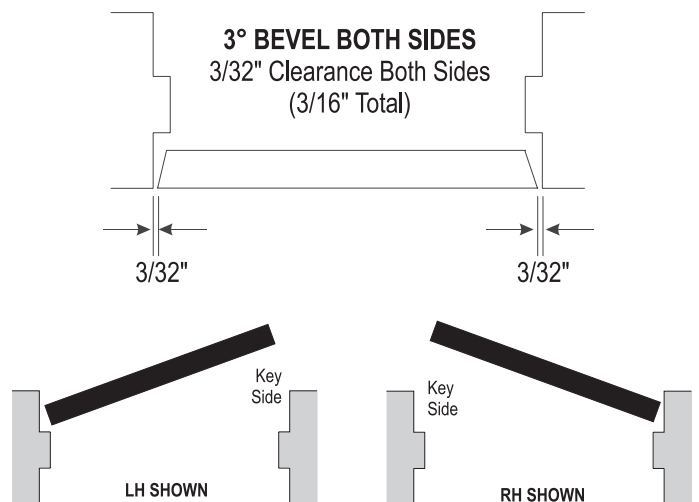

STANDARD HINGE AND STRIKE LOCATIONS

1-3/4" DOOR WITH 2 PAIR OF 4-1/2" HINGES

NET FRAME DIMENSIONS					
RFS 35, RFS 36, RFS 37					
NOM HGT.	NET HGT.	"A"	"B"	"C"	"D"
6'-0	72-3/16	10-19/32	17	17	32-3/32
6'-8	80-3/16	10-19/32	19-1/2	20	40-3/32
6'-9	81-3/16	10-19/32	20	20	41-3/32
6'-10	82-3/16	10-19/32	20-1/4	20-1/2	42-3/32
7'-0	84-3/16	10-19/32	21	21	44-3/32
7'-2	86-3/16	10-19/32	21-1/2	22	46-3/32
7'-4	88-3/16	10-19/32	22-1/4	22-1/2	48-3/32
7'-6	90-3/16	10-19/32	23	23	50-3/32
7'-8	92-3/16	10-19/32	23-1/2	24	52-3/32
7'-10	94-3/16	10-19/32	24-1/2	24	54-3/32
8'-0	96-3/16	10-19/32	25	25	56-3/32
8'-2	98-3/16	10-19/32	25-1/2	26	58-3/32
8'-4	100-3/16	10-19/32	26-1/4	26-1/2	60-3/32
8'-6	102-3/16	10-19/32	27	27	62-3/32
8'-8	104-3/16	10-19/32	27-1/2	28	64-3/32
8'-10	106-3/16	10-19/32	28-1/2	28	66-3/32
9'-0	108-3/16	10-19/32	29	29	68-3/32

DOOR PREFITTING: Deduct 3/32" from dimensions "A" and "D" for clearances.

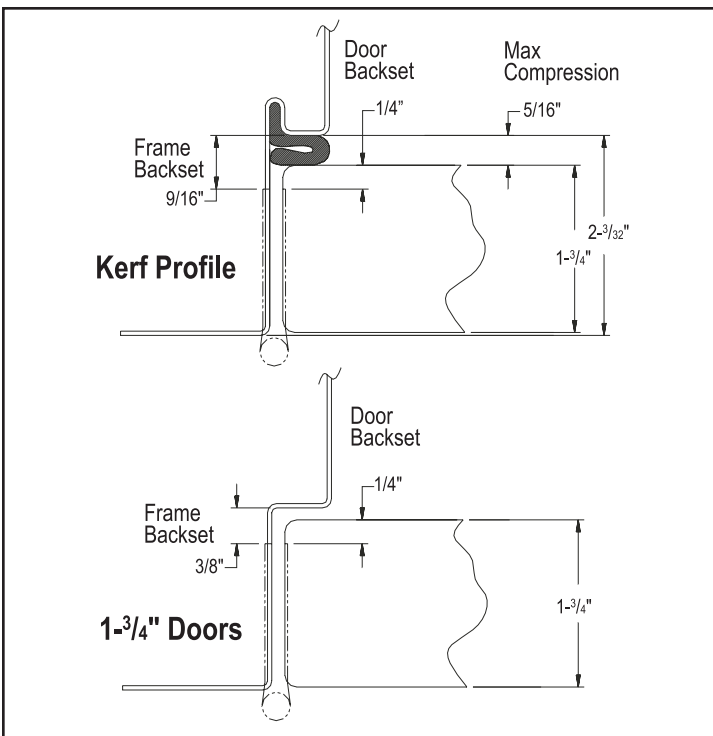
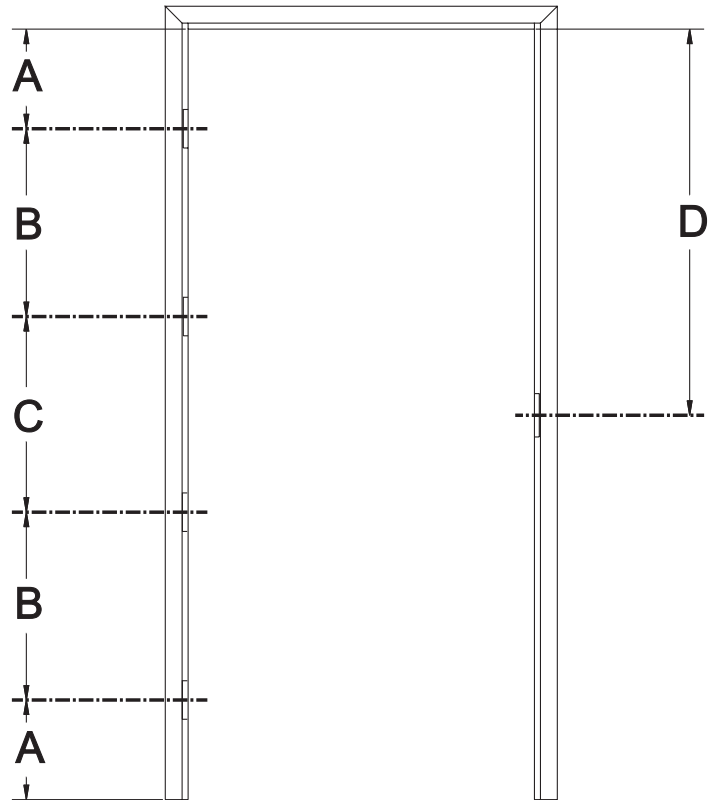

DOOR INFORMATION:
 Hinge Backset = 1/4"
 Hinge Depth = .134" for standard weight hinge
 Hinge Depth = .180" for heavy weight hinge
 Template hinge pattern only

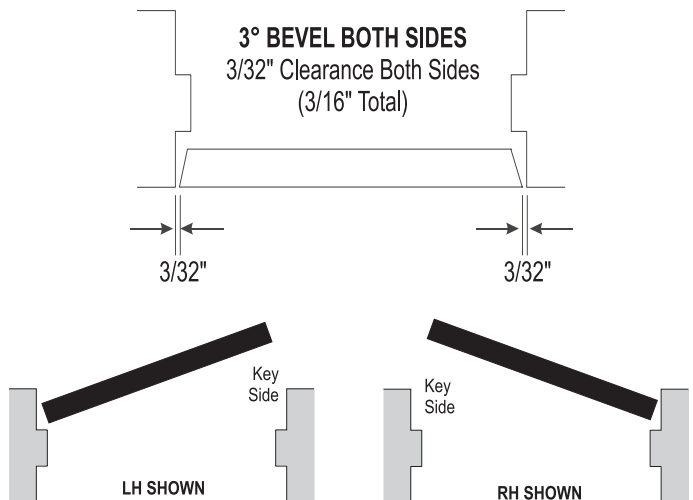

DUTCH DOOR PREP; 1-3/8" DOOR WITH 2 PAIR OF 3-1/2" HINGES

NET FRAME DIMENSIONS						
RFS 16						
NOM HGT.	NET HGT.	"A"	"B"	"C"	"D"	"E"
6'-0"	72-3/16"	4-27/32"	22-1/2"	9-1/2"	30-1/2"	36-3/32"
6'-8"	80-3/16"	4-27/32"	30-1/2"	9-1/2"	30-1/2"	44-3/32"
6'-9"	81-3/16"	4-27/32"	31-1/2"	9-1/2"	30-1/2"	45-3/32"
6'-10"	82-3/16"	4-27/32"	32-1/2"	9-1/2"	30-1/2"	46-3/32"
7'-0"	84-3/16"	4-27/32"	34-1/2"	9-1/2"	30-1/2"	48-3/32"
7'-2"	86-3/16"	4-27/32"	36-1/2"	9-1/2"	30-1/2"	50-3/32"
7'-4"	88-3/16"	4-27/32"	38-1/2"	9-1/2"	30-1/2"	52-3/32"
7'-6"	90-3/16"	4-27/32"	40-1/2"	9-1/2"	30-1/2"	54-3/32"

DOOR PREFITTING: Deduct 3/32" from dimensions "A" and "E" for clearances.

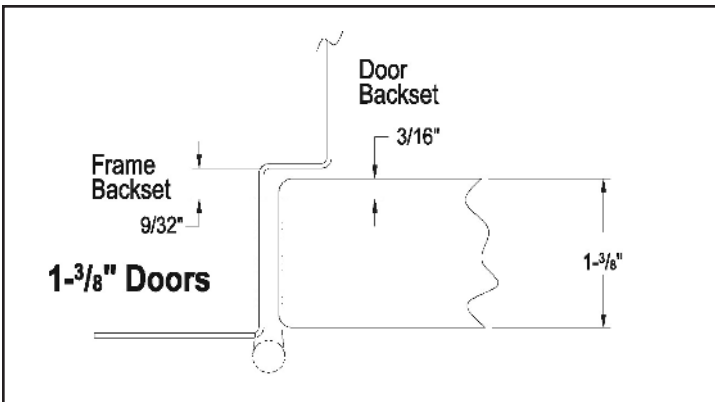
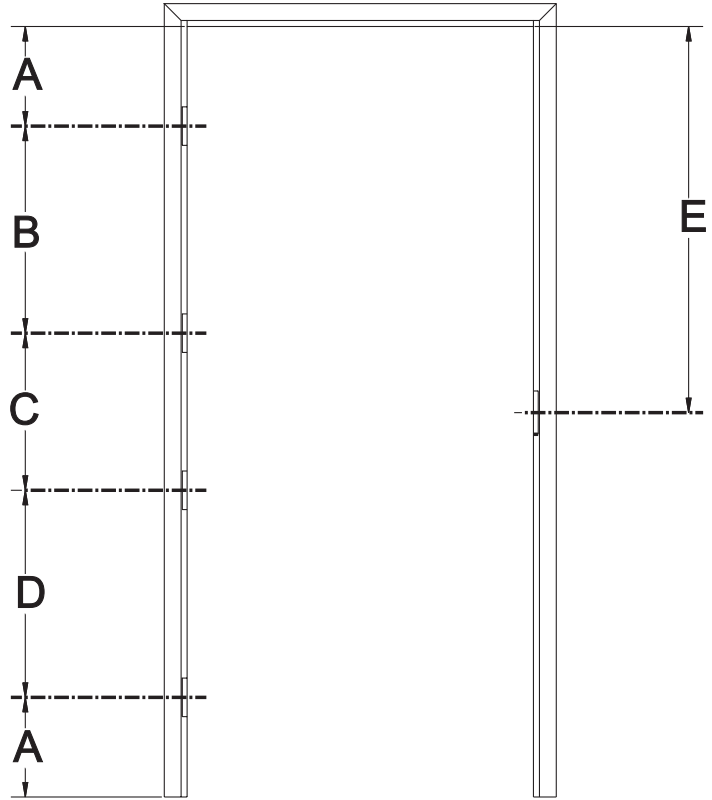

DOOR INFORMATION:
 Hinge Backset = 3/16"
 Hinge Depth = Per Template
 Template hinge pattern only; 1/4" or 5/8" radius

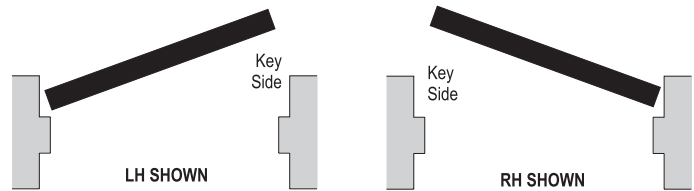
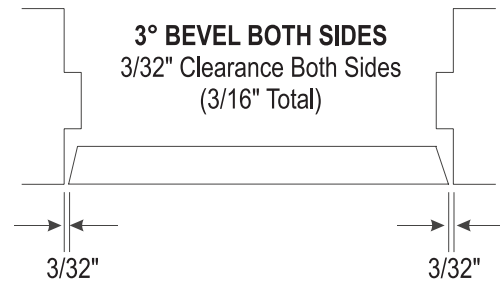

STANDARD HINGE AND STRIKE LOCATIONS

DUTCH DOOR PREP; 1-3/4" DOOR WITH 2 PAIR OF 4" HINGES

NET FRAME DIMENSIONS						
RFS 40						
NOM HGT.	NET HGT.	"A"	"B"	"C"	"D"	"E"
6'-0	72-3/16	5-3/32	22	10	30	36-3/32
6'-8	80-3/16	5-3/32	30	10	30	44-3/32
6'-9	81-3/16	5-3/32	31	10	30	45-3/32
6'-10	82-3/16	5-3/32	32	10	30	46-3/32
7'-0	84-3/16	5-3/32	34	10	30	48-3/32
7'-2	86-3/16	5-3/32	36	10	30	50-3/32
7'-4	88-3/16	5-3/32	38	10	30	52-3/32
7'-6	90-3/16	5-3/32	40	10	30	54-3/32

DOOR PREFITTING: Deduct 3/32" from dimensions "A" and "E" for clearances.

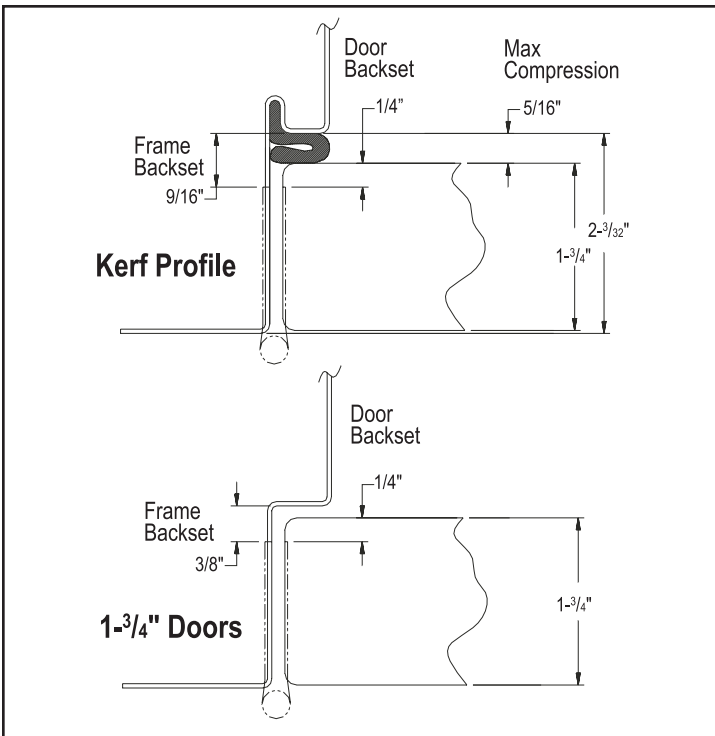
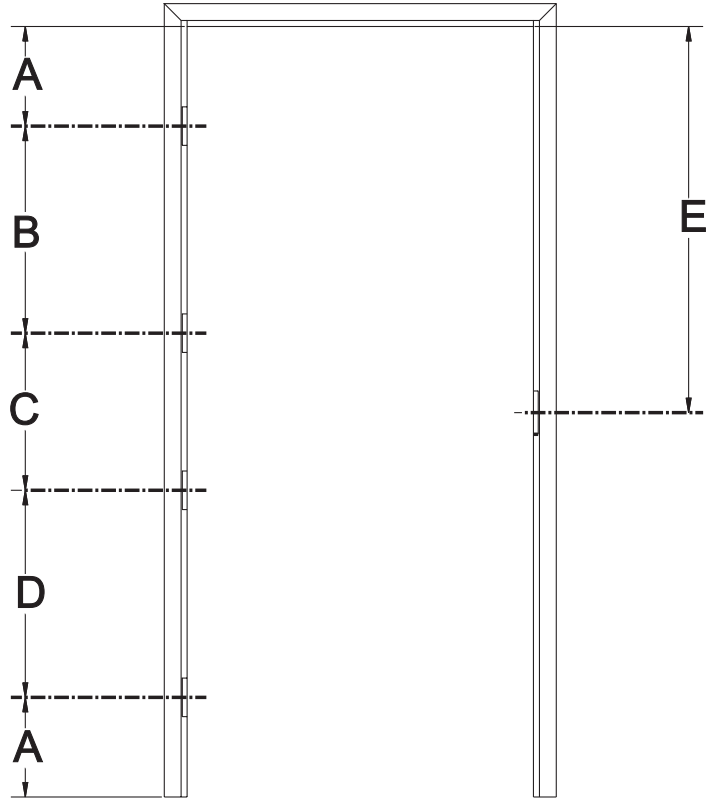

DOOR INFORMATION:
 Hinge Backset = 1/4"
 Hinge Depth = Per Template
 Template hinge pattern only; **1/4" radius only**
 5/8" Radius hinge prep available in template or non-template hole pattern; specify hinge when ordering.

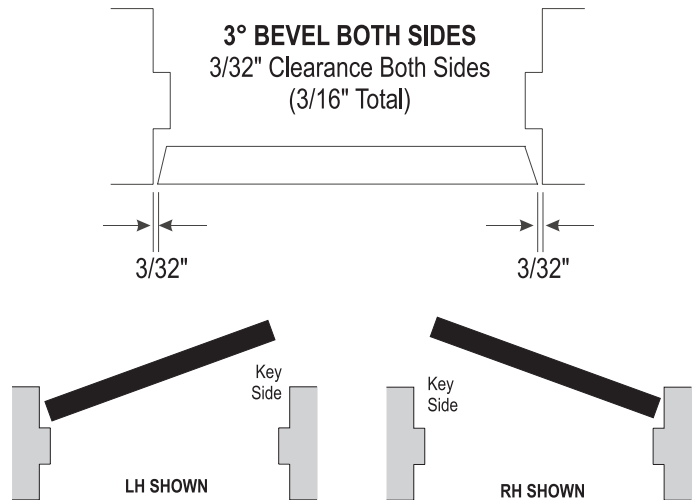

DUTCH DOOR PREP; 1-3/4" DOOR WITH 2 PAIR OF 4-1/2" HINGES

NET FRAME DIMENSIONS						
RFS 41						
NOM HGT.	NET HGT.	"A"	"B"	"C"	"D"	"E"
6'-0"	72-3/16"	5-11/32"	21-1/2"	10-1/2"	29-1/2"	36-3/32"
6'-8"	80-3/16"	5-11/32"	29-1/2"	10-1/2"	29-1/2"	44-3/32"
6'-9"	81-3/16"	5-11/32"	30-1/2"	10-1/2"	29-1/2"	45-3/32"
6'-10"	82-3/16"	5-11/32"	31-1/2"	10-1/2"	29-1/2"	46-3/32"
7'-0"	84-3/16"	5-11/32"	33-1/2"	10-1/2"	29-1/2"	48-3/32"
7'-2"	86-3/16"	5-11/32"	35-1/2"	10-1/2"	29-1/2"	50-3/32"
7'-4"	88-3/16"	5-11/32"	37-1/2"	10-1/2"	29-1/2"	52-3/32"
7'-6"	90-3/16"	5-11/32"	39-1/2"	10-1/2"	29-1/2"	54-3/32"

DOOR PREFITTING: Deduct 3/32" from dimensions "A" and "E" for clearances.

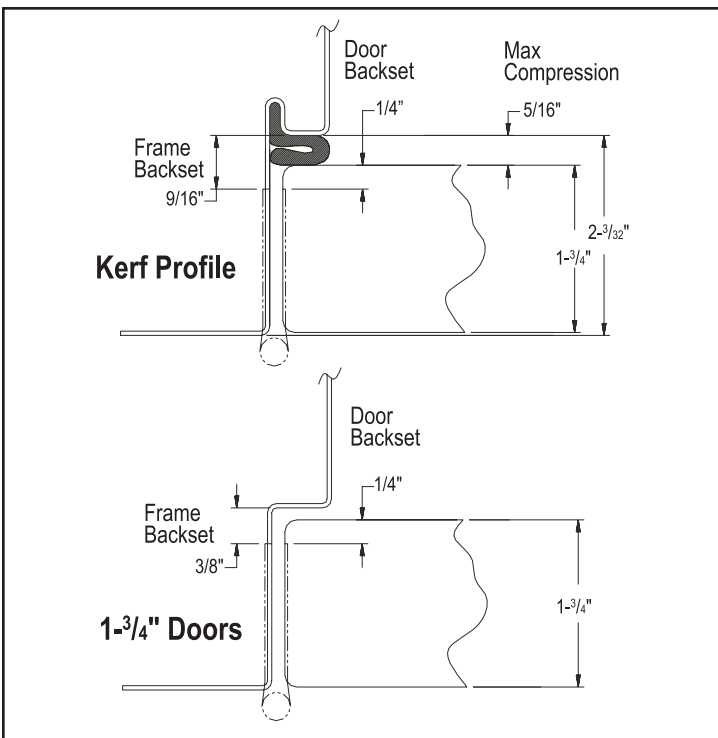
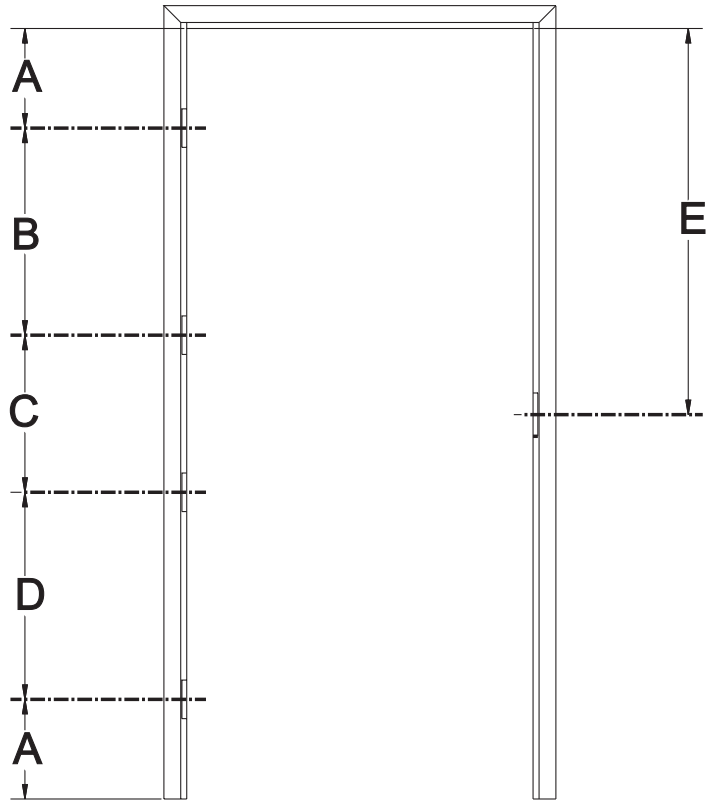

DOOR INFORMATION:
 Hinge Backset = 1/4"
 Hinge Depth = .134" for standard weight hinge
 Hinge Depth = .180" for heavy weight hinge
 Template hinge pattern only

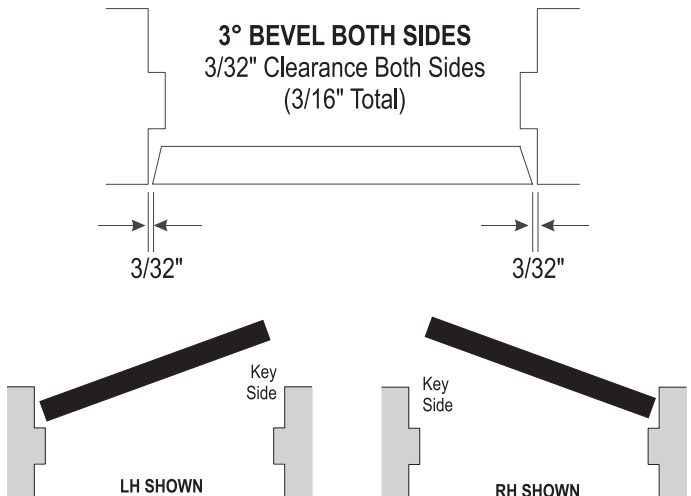

STANDARD HINGE AND STRIKE LOCATIONS

1-3/4" DOOR WITH 1-1/2 PAIR OF 5" HINGES

NET FRAME DIMENSIONS

NOM HGT.	NET HGT.	"A"	"B"	"C"
5'-0	60-3/16	10-27/32	19-1/4	20-3/32
5'-1	61-3/16	10-27/32	19-3/4	21-3/32
5'-2	62-3/16	10-27/32	20-1/4	22-3/32
5'-4	64-3/16	10-27/32	21-1/4	24-3/32
6'-0	72-3/16	10-27/32	25-1/4	32-3/32
6'-8	80-3/16	10-27/32	29-1/4	40-3/32
6'-9	81-3/16	10-27/32	29-3/4	41-3/32
7'-0	84-3/16	10-27/32	31-1/4	44-3/32
7'-4	88-3/16	10-27/32	33-1/4	48-3/32
7'-6	90-3/16	10-27/32	34-1/4	50-3/32

DOOR PREFITTING: Deduct 3/32" from dimensions "A" and "C" for clearances.

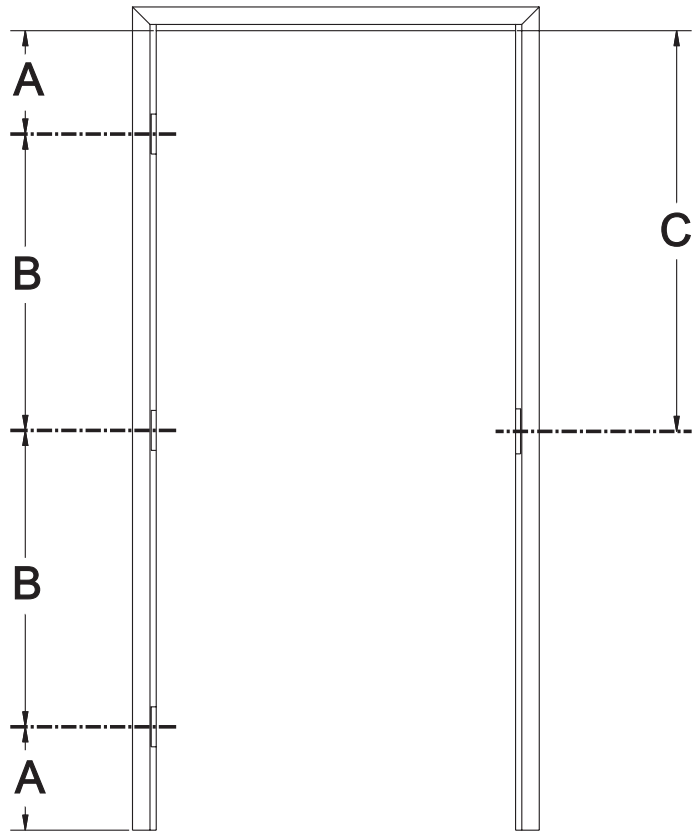

DOOR INFORMATION:

Hinge Backset = 1/4"
 Hinge Depth = .145" for standard weight hinge
 Template hinge pattern only

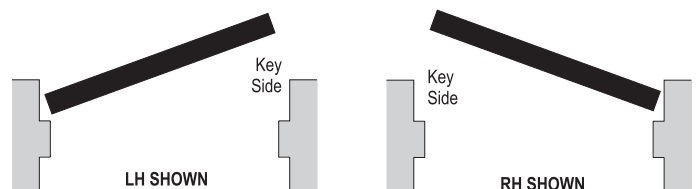
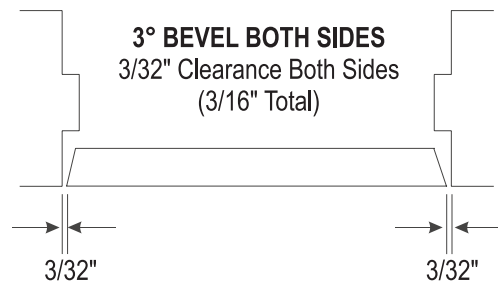
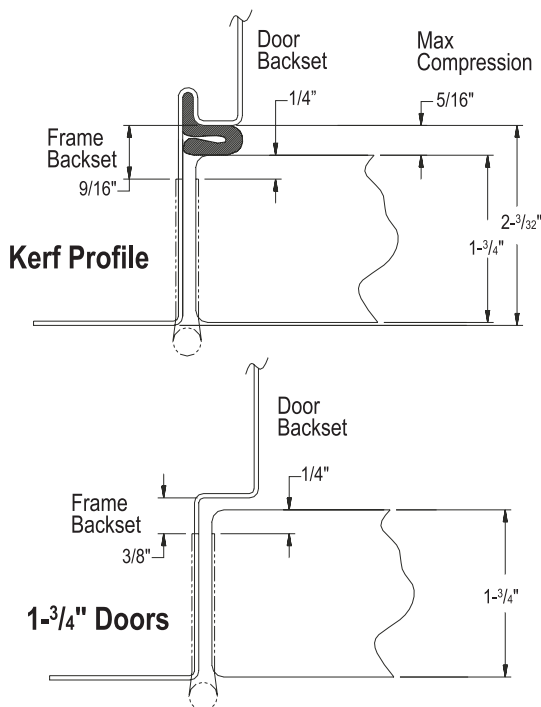



REDIFRAME

1101 Technology Drive | Dothan, Alabama 36303
800.633.7553 | 334.794.9184 fax
www.dunbarton.com | sales@dunbarton.com